

K:\TZ-Hauptordner\Technisches Detail\Tuergriff (DWG)\SA.3300_1.dwg

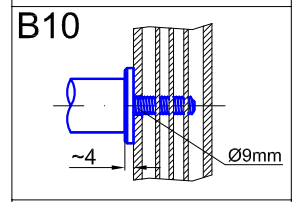
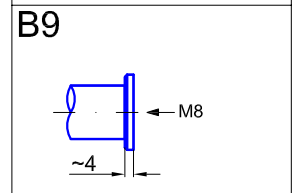
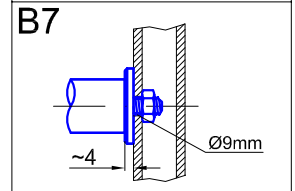
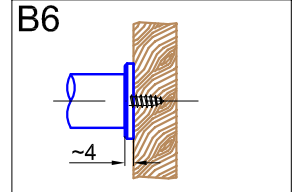
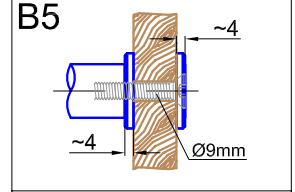
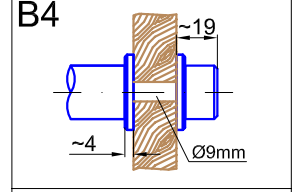
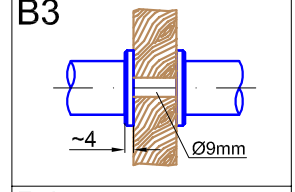
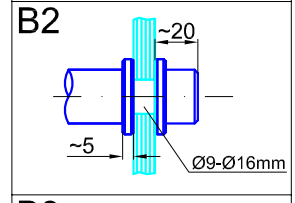
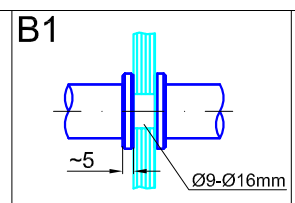
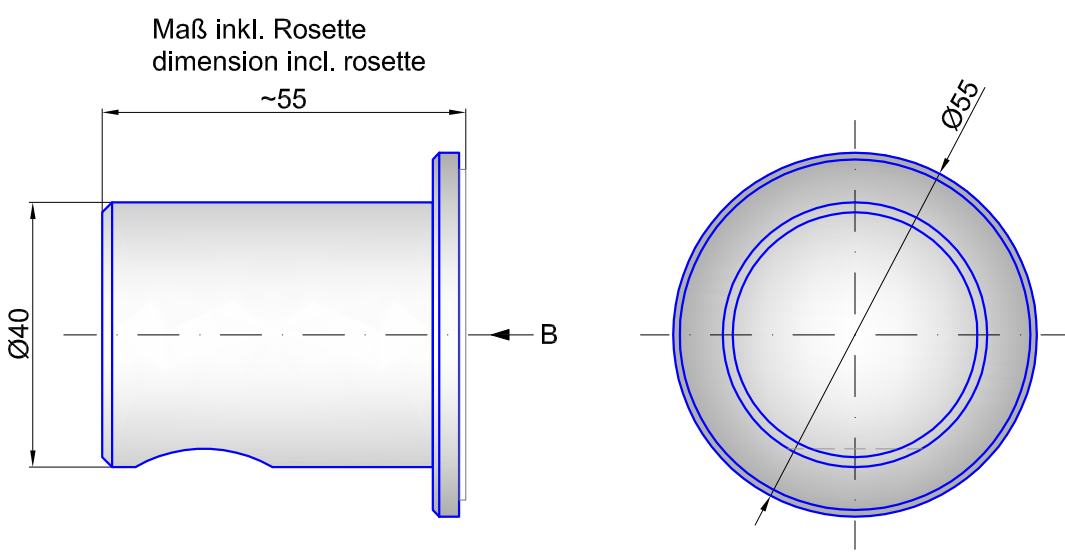

Befestigung **B** immer für
2 Stück Griffstützen!

Mounting parts **B** for
2 pieces of door handle support!

Technische Änderungen vorbehalten - Subject to change without notice



Am Steinbusch 7
48351 Everswinkel
Tel.: 02582-9960-0
Fax: 02582-9960-29
info@mwe.de
www.mwe.de

Bezeichnung:	Griffknauf		
description:	Door knob		
Modell: model:	SA.3300	CAD-Maßstab: CAD-scale:	1:1
		Datum: date:	10.11.05